

English

Marana



MADE IN ITALY

**Marana**<sup>®</sup>

**FORNI**

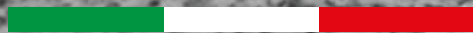



# Pizza ovens

---

Since 1992

# Table of Contents

COMPANY	5
SUSTAINABILITY AND CERTIFICATIONS	7
WHY MARANA FORNI	9
SHOWROOM	11
MODELS	12
Rotoforno SU&GIU®	13
Rotoforno Classico	14
Rotoforno Genius	15
Napulé	16
Fisso 120	17
STRENGTHS	
Rotation	18
Microperforated Plate	19

Turbo / Up-and-over door	20
Designs/Console	21
Easy installation	22
Other strengths	23

## FUEL TYPES

Wood / Gas	24
Pellet / Combination	25

## COVERINGS

Domes Napoli	26
Gea	27
Tanganelli	28
Trofeo 85	29

## TECHNICAL CHARACTERISTICS

Rotating	30
Static	32
Pizza diagram	34
Technical Sheets	36
Consumption, chimneys, and draughts	37

## MARANA FORNI AROUND THE WORLD 39

## OUR CUSTOMERS 42

A photograph of a modern building with a curved facade, illuminated at night. The building's exterior is clad in vertical, reddish-brown panels. A large, curved sign at the top of the building reads "Marana For...". Above the sign, the words "VERVA" and "ITALIA" are visible. The building has several windows, some of which are lit from within, casting a warm glow. The sky is dark blue, and there are some trees and bushes in the foreground.

VERVA  
ITALIA  
Marana For...

## The result of a simple and effective idea

---

“Everybody knew it was impossible, until a fool who didn’t know came along and did it.”

*Albert Einstein*

## The company



In the late 1980s **Ferdinando Marana** dreamed of a wood-fired or gas pizza oven that rotated pizzas on its own with a cook plate that's always hot. The goal was to cut wait times and take pizzas out of the oven always cooked to perfection, from the beginning of the shift to the end.

After a few years of in-depth study, in **1992 Marana Forni** was born and with it, the first patent in the world for a rotary pizzeria oven: the Rotoforno SU&GIU® was created.

The inoculation of **technology** into such a conventional product like the wood-fired oven initially only won over the more forward-thinking pizza-makers, but in just a few years the word spread and the revolution took hold until it became an institution, today found in **over 85 countries worldwide**. The pizzas popping out of Marana ovens every day number in the hundreds of thousands.

Today the company fuels continuous **development** in the world of wood-fired, gas, pellet, and combination pizza ovens, with new patents and concepts that time and again are ahead of market demands.





# We invest in the future

Our commitment towards sustainable development

## Sustainability



Since the year 2020, the company has embarked on a **path towards sustainability** to improve its environmental and social performance, which brings it to prepare an annual report. This report communicates Marana Forni's commitment – both in-company and to the outside world – to sustainability and to improve its business to contribute to **sustainable development**.

Plus, since 2012 there are **solar panels** on the roof of the main warehouse.

## Certifications





# The inventors of the rotating pizzeria oven

Ovens that have revolutionized the world of pizza in terms of cooking quality and speedy service.



## Why Marana



**1** We have invented and patented the **Rotoforno®**, the first rotating oven for pizza.

**2** We have invented and patented **SU&GIU®**, the only rotating oven with a cook plate that rises.

**3** Our ovens are the most **copied** in the world.

**4** We don't compromise on the **quality** of material.

**5** We've been on the market for **30 years** and are constantly evolving

**6** Our ovens are loved in Italy and in **over 85 countries** around the world.

**7** Since 1995 we have been the **official technical partner** of the World Pizza Championship, and in many other shows, like the French Championship and Spanish Championship for example.

**8** We are **state-of-the-art** in the fields of technology, material, covering, and look.

Our product **certifications**:

- European
- Canadian Standard Association
- National Sanitation Foundation
- Underwriters Laboratories Inc
- Associazione Verace Pizza Napoletana

**10** Because there isn't just one Marana oven, there is your Marana Oven, entirely **personalizable** based on your needs.



These Italian-made ovens are all over Italy  
and in 85 countries around the world.

The worldwide fame of pizza is best expressed thanks to the international vocation of Marana Forni which, with the support of a structured sales team, well-established in various countries around the world, allows pizza-makers from any country to rely on ad hoc services and experience to successfully follow through with their projects.

## Showroom

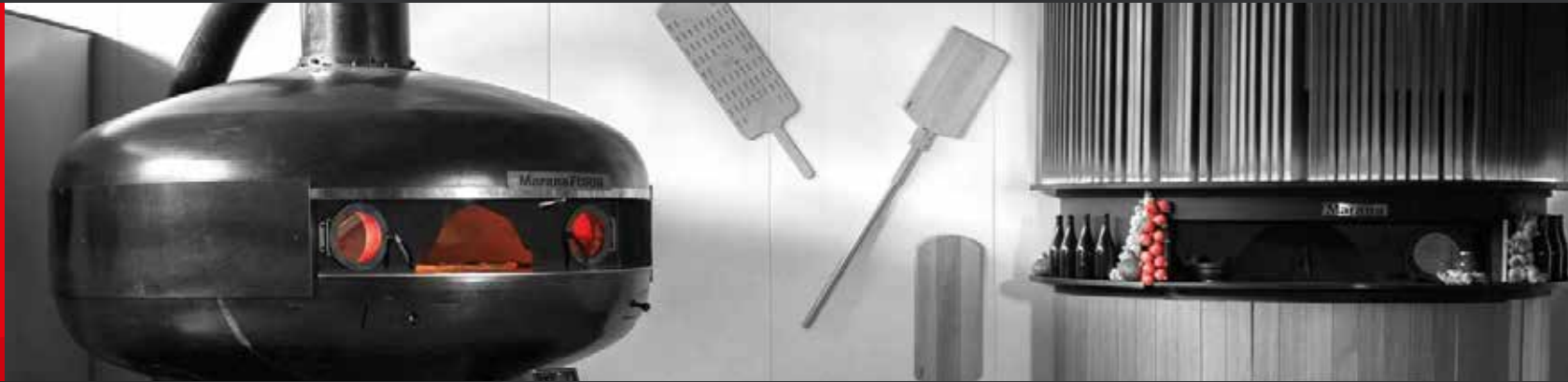

You can bring your dough or your raw ingredients to Marana Forni showrooms around the world and use our ovens. **You will be attended to during tests**, in order to ascertain the perfect cooking and ideal work method for you, give any suggestions for your business, or answer any other question you'd like to ask us for a complete service.

We also cater to teams of pizza-makers, cooks, and industry schools that would like to organize **professional classes** at the company offices to allow for specific training on our ovens and on pizza in general.



# Our Ovens

---

## Rotary Ovens

Ovens that have revolutionized the world of pizza  
in terms of cooking quality and speedy service

*Check out the range from p. 13*

## Fixed Ovens

For Neapolitan pizza,  
a UNESCO world heritage, and more

*Check out the range from p. 16*

Rotoforno  
SU&GIU®

Rotoforno  
CLASSICO

Rotoforno  
GENIUS

Napulé

Fisso 120

# Rotoforno SU&GIU®

## The oven with three cooking levels

Savings on fuel, perfect cooking even at low temperature, heating of the cook plate in just a few seconds. SU&GIU has the same characteristics as the Rotoforno Classico, plus implementation of plate lifting system.

It always cooks at the **ideal temperature** thanks to the rotating plate that can rise towards the dome to find the temperature. Plus, it guarantees less consumption of fuel. If when there is a lull in the work we always keep a high temperature, **we are consuming fuel for no reason**. In these circumstances, SU&GIU® keeps the temperature lower, because by lifting the cook plate the pizzas get closer to the dome where there are from 40 to 100°C more.

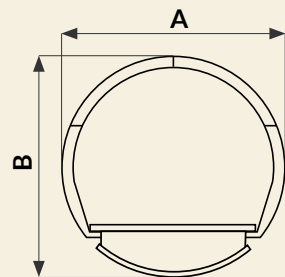

### Technical characteristics

MODEL	A	B	Pizza capacity Ø 29	Pizza capacity Ø 33
95	152	152	7	5
110	180	180	9	7
130	200	200	13	9
150	220	220	18	13

Sizes in centimeters with a +/- 1% variation

### Fuels



WOOD



GAS



PELLET



COMBINATION



# Rotoforno CLASSICO



## The king of rotating ovens

The pizza-maker concentrates on the quality of his work, while the rotating oven cooks the pizzas. Rotoforno works like an independent helper for making pizzas that emits a sound when cooking is done so that the pizza-maker can put in the pizzas he has just artfully topped.

It is an ongoing, linear work cycle.

The operation of the Rotoforno facilitates the pizza-maker's tasks and streamlines his work. So in the peak hours of service Rotoforno lets you serve customers faster, majorly cutting wait times and getting rid of downtime.

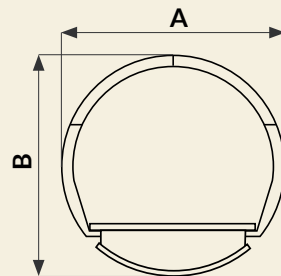

### Technical characteristics

MODEL	A	B	Pizza capacity Ø 29	Pizza capacity Ø 33
85	136	136	5	4
95	152	152	7	5
110	180	180	9	7
130	200	200	13	9
150	220	220	18	13

Sizes in centimeters with a +/- 1% variation

### Fuels



WOOD



GAS



PELLET



COMBINATION



# Rotoforno GENIUS

## Perfect cooking **just once around**

**Anybody can make not just any pizza.**

While Genius cooks, all the pizza-makers have to do is take out the pizza that passes in front of them and put in another in its place, and then the next, and so on. It is an ongoing, linear work cycle.

Genius automatically handles the three algorithms of time, temperature, and flame strength, according to its type of pizza, and lets you always cook in one cook plate rotation. It's an independent baker.

**Genius always knows what to do** to achieve the best results using the least amount of fuel. More and more franchised chains around the world use Genius.

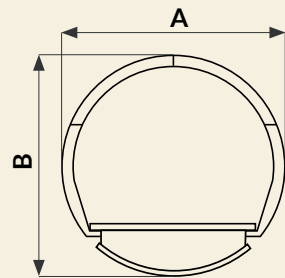

### Technical characteristics

MODEL	A	B	Pizza capacity Ø 29	Pizza capacity Ø 33
110	180	180	9	7
130	200	200	13	9
150	220	220	18	13

Sizes in centimeters with a +/- 1% variation

### Fuels



WOOD



GAS



COMBINATION



## Napulé



### Parthenopean Heart

Certificate from the **Associazione Verace Pizza Napoletana** (True Neapolitan Pizza Association), both for wood and gas-burning; contains volcanic rock from Vesuvius.

This oven is the result of a close collaboration and experimentation that Marana Forni carried on with **master Neapolitan pizza-makers**.

Important teamwork in which the Neapolitan experience and the company's handicraft technology breathed life into a unique tool that, since it always keeps the plate hot, leads to extraordinary cooking even during long shifts.

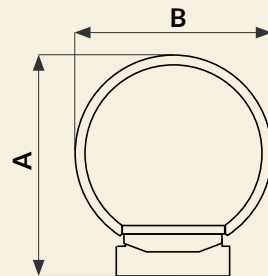

#### Technical characteristics

MODEL	A	B	Pizza capacity wood	Pizza capacity gas
Napulé	152	176	5 Ø 33cm	7 Ø 33cm

Sizes in centimeters with a +/- 1% variation

#### Fuels



WOOD



GAS



COMBINATION





# Fisso I20

## Tradition by Marana

Always perfect cooking, also guaranteed for very high production.

It is the result of tests which were carried out at the company –where the stones that made Marana ovens famous were used categorically– to end up with this traditional oven suitable to any type of pizza.

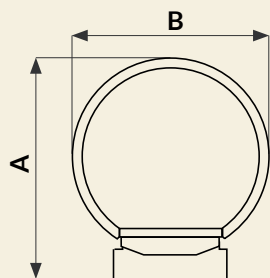

### Technical characteristics

MODEL	A	B	Pizza capacity wood	Pizza capacity gas
Fisso 120	152	176	5 Ø 33cm	7 Ø 33cm

Sizes in centimeters with a +/- 1% variation

### Fuels



WOOD



GAS



COMBINATION



## SU&GIU® Lifting system of the cook plate



### Fuel savings

The **SU&GIU® function** maintains a temperature of even 100°C below the ideal one, because the pizza-maker can lift the cook plate to one of two heights above it: at the first height you recoup about 40-50 °C and at the second, about 80-100 °C.

There are times when it's slow during a pizzeria shift, when you put in less pizza, but the pizza-maker is required to always keep the ideal temperature to be able to **cook adequately**.

One example is the last half hour of the shift; nonstop service; lunch during the week; Monday night, etc. If we always keep a high temperature, we are always **consuming fuel** for no reason, and in any event, you risk **overheating** the cook plate and then burning the pizzas.

Thanks to **SU&GIU®**, a Marana Forni patent, you can adjust the height of the cook plate to choose the **right temperature** that your pizza needs.



## Micro-perforated plate

### Perfect cooking

A fragrant bake and **fast heat recovery** thanks to the special finish the cook plate surface is made out of.

The alveolar microperforation keeps the pizza slightly “uplifted”, allowing it to **release moisture and flour**. Plus, the total surface area is greater than that of a smooth surface, so the exposure to irradiation is greater, resulting in fast heat recovery.

Also available smooth for those who stick to tradition.



## Turbo Wood or Gas



### Turbo Wood

Thirty-three percent of the heat that the wood forms in the oven comes from the embers, and during the busiest shifts you can move them under the cook plate to keep it hot. Thanks to the Turbo Wood, the heating system patented in 1995, you can use the embers as an extra heat source: **higher yield, and more savings**. When the embers become ashes, they fall in a drawer, helping the pizza-maker keep the oven clean.

### Turbo gas

A burner situated under the cook plate that optimizes heating and maximizes the yield of the gas, thus **cutting costs** and keeping the plate hot.

## Energy savings

**Energy savings and heat maintenance:** these are the functions of Marana's oven doors. They are slit at the top to let in the oxygen the fire needs to burn, but without it going over the cook plate. You can use them in slower-paced moments or during oven preheating when you don't have to constantly fill and take pizzas out. In the rotating models you use them in combination with the air intake under the oven which allows **optimal heat circulation**.

## "C" door or Up-and-over door

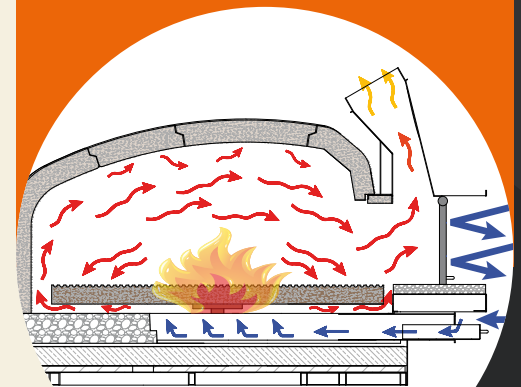

## Designs



### It's easy to go **from one oven to the next**

Option to easily change the oven from **combustion to another type** or from one model to another **later on**. For example, you can buy a wood-fired Rotoforno and years later change it to a gas one, or vice versa. Or even still, from a Rotoforno Classico to a Rotoforno Genius, for example.

### User-friendly and **practical**

Depending on the model the consoles come with a joystick and/or simple buttons, built so that all the oven's parameters are at your fingertips.

The Patch Consoles you immediately **replace the main console** so that you can change it if you need to by unplugging the cable and connecting the other one in a few seconds without tools and with just one hand.

## Consoles



## Easy installation



Our ovens can be installed **anywhere**

Our ovens can be delivered preinstalled or installed on site, so you can also install it in places with **just 70-cm wide** passageway.

## Efficiency above all else

The cooking body of Marana's ovens has **mechanical resistance** and **resistance to wear and tear**, with a high ability to **accumulate and hold in heat** and strong irradiation.

**3200 kg/m<sup>3</sup>** versus the approximate 1800/2200 m<sup>3</sup> of an everyday refractory. Three times more resistant to porphyry and wear and tear.

## Very efficient stones



## Other Strengths



### The characteristics that make our ovens **unique**

- **With SU&GIU®** it's easy to cook **different types of pizza**, exploiting the different temperatures that you get by raising the cook plate. Plus, you can **cook food** at one surface height, and pizza at a higher one.
- **Do ovens that last forever exist?** An efficient oven brings more gains in the bank and in life: Marana creates products where all the wear-and-tear parts can be quickly and affordably changed without having to take the **entire oven apart**, throughout the oven's entire lifespan. Each part is long-lasting and **easily replaceable**.
- **Pizza-makers can devote themselves to the pizza:** the opening, topping, and the look. The oven becomes ergonomic, **it lets you know** when the cooking time is up, the done pizzas need to be taken out, and those just made put in, making for outstanding psychological and physical well-being. **Getting rid of downtime** and yielding **optimal cooking**.
- When the pizza oven is in plain sight at a restaurant, often it's a **beautiful job tool, but one that's been seen before**. Marana Forni's domes come in an array of **2000 colors** from which to choose, but that the customer can also personalize to make them become a **unique item** the world over.



## Wood



### The tradition

The combustible fuel par excellence, **the best wood for cooking is dry and aged** (15-20% moisture), preferably hardwood (oak, beech, and olive). Alternatively, great compressed wood blocks are sold in stores.

### Practicality

**The Complete MRN Gas System** is a cooking system that communicates with the oven's console and can automatically maintain the desired temperature with five cooking flame levels.

It is a smart system that **lowers the flame but never puts it out**, so that all the pizza cooking always takes place with the flame on. The flame has a long, bright wood effect.

## Gas





## Pellet



### Practical and **ecological**

Pellet, as opposed to common wood, **produces very little smoke and ash** and burns on its own at various flame strengths thanks to the Marana Forni-patented system. It gives off **more heat than wood** and its flame is light, combining the tradition of wood-fired cooking with the convenience of gas. It is a biomass, so it's more ecological than gas, not being a fossil fuel.

### Tradition and practicality **all in one**

**The traditionality of wood and the practicality of gas** all in one. You can use either one alternatively. The gas burners have a long, bright wood-effect flame.

## Combination



## Napoli Domes



### Napoli RAL Domes

An array of 2,000 shades in the entire RAL chart from which to choose, and for each one you also get to choose between glossy and matte. The RAL domes are installed already painted on-site.



#### FUELS



WOOD



GAS



COMBINATION

**SIZES:** 85 - 95 - 110 - 130

#### MODELS:

Rotoforno Classico, Rotoforno SU&GIU,  
Rotoforno Genius, Napulé, Fisso 120

### Napoli Blank Domes

A “blank slate” that you can get creative on, bestowing a rustic or contemporary look. For example, you can add a mosaic or create graffiti, or paint it different colors, however you'd like!



#### FUELS



WOOD



GAS



COMBINATION

**SIZES:** 85 - 95 - 110 - 130 - 150

#### MODELS:

Rotoforno Classico, Rotoforno SU&GIU,  
Rotoforno Genius, Napulé, Fisso 120

### Napoli Colors Domes

Seven different colors of your choice, all in brushed metal with highlights that change depending on the lighting at your place. For an original oven with an unmistakable personality



#### FUELS



WOOD



GAS



COMBINATION

**SIZES:** 85 - 95 - 110 - 130

#### MODELS:

Rotoforno Classico, Rotoforno SU&GIU,  
Rotoforno Genius, Napulé, Fisso 120

## Gea

### Spaceship or oven?

Two-thousand five hundred kg floating in a bubble –a look reminiscent of the **old foundries** from the start of the last century, a special iron and steel finish.

If you ever come across GEA you can't help but notice it because it looks like an optical illusion. GEA can be hung from the ceiling or on a free-standing arm. It has a 150-cm cook plate with a **high production capacity**.

The only rotary oven with a flame on both sides, it was born right before 2000 to meet the demands of a Chinese customer who wanted an oven that resembled an onion.

#### FUELS



WOOD



GAS



COMBINATION

SIZES: 150

#### MODELS:

Rotoforno Classico, Rotoforno SU&GIU, Rotoforno Genius



## Tanganelli



### A welcoming element

Placed in the middle of restaurants as a kind of hearth **symbolizing togetherness** so that the rite of making pizza becomes the real star in the spotlight and the diners become the audience members of this “cooking show”.

The brainchild of architect Andrea Tanganelli, winner of the competition called by Marana Forni in association with Florence University’s Faculty of Architecture and Design Technologies, it is a covering both **innovative and conventional** at the same time.

Tanganelli can go through any entrance just 70 cm wide, so it can be installed on-site.

#### FUELS



WOOD



GAS



COMBINATION

SIZES: 110, 130, 150

#### MODELS:

Rotoforno Classico, Rotoforno SU&GIU, Rotoforno Genius



## Trofeo 85

### A great little jewel

Perfect at a boutique, food truck, food courts –and why not?– as an auxiliary alongside larger ovens for gourmet or gluten-free pizzas, bread, and restaurant dishes.

Trofeo is a **little oven that makes a great impression.**

Just a little bigger than a person, it's chameleonlike and adapts to both rustic and traditional settings with any color.



#### FUELS

SIZES: 85



WOOD



GAS



COMBINATION

#### MODELS:

Rotoforno Classico

### Stones

3.200 kg/m<sup>3</sup>: extremely high performance as far as storing, transferring, and recovering heat

### Fuels

Wood, gas, pellet, or combination

### Micro-perforated plate

A fragrant bake and fast heat recovery

### TURBO wood or gas

Additional heating under the cook plate

### Consoles

User-friendly, practical, replaceable in just a few seconds



# Rotary ovens

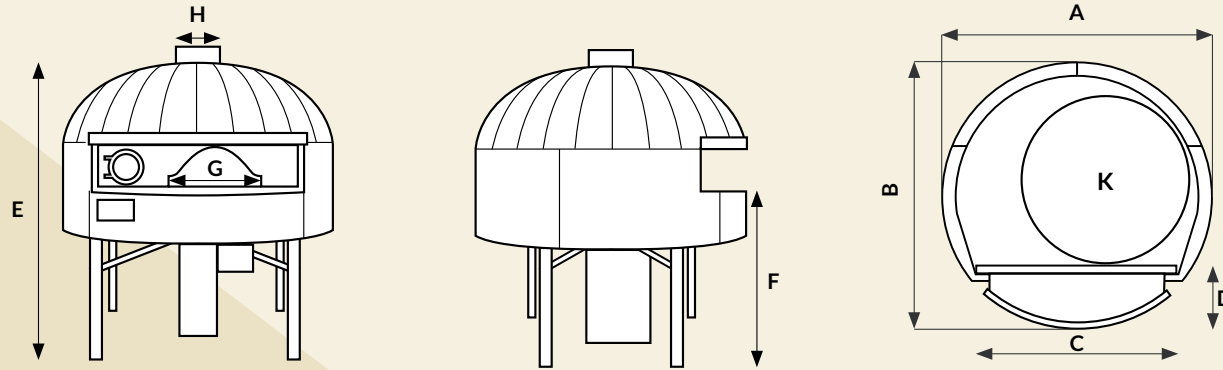

A Oven Width  
B Oven Depth  
E Oven Height  
F Counter Height  
G Mouth Width  
H Exhaust Structure Diameter  
C Width in front  
D Depth of the Front  
K - PIZZA CAPACITY

## Measurements and consumption of the models

MODEL	H	A	B	C	D	E	F	G	K - PIZZA CAPACITY	WEIGHT kg
85	Ø 20	136	136	91	30	195*	120*	46	Ø 29cm x5 Ø 33cm x4	770
95	Ø 20	152	152	100	33	187*	120*	45	Ø 29cm x7 Ø 33cm x5	940
110	Ø 20	180	180	125	45	205*	120*	60	Ø 29cm x9 Ø 33cm x7	1400
130	Ø 20	200	200	125	45	205*	120*	60	Ø 29cm x13 Ø 33cm x9	1710
150	Ø 20	220	220	125	45	205*	120*	60	Ø 29cm x18 Ø 33cm x13	2170

Sizes in centimeters with a +/- 2% variation (\*) Different sizes upon request.

Electric Characteristics	VOLT		HERTZ		MOTOR POWER	
	220/230 - SINGLE-PHASE		50/60		ROTO = 0,13 kW ROTO SU&GIU = 0,46 kW	
Characteristics of the Gas System	REQUIRED PRESSURE			Ø GAS BURNER CONNECTION		
	METHANE - 20 Mbar		LPG - 37 Mbar	¾ INCH MALE COUPLING		

MODEL	HOURLY CONSUMPTION OF FUEL - HEATING					HOURLY CONSUMPTION OF FUEL - COOKING				
	WOOD kg	METHANE m³	LPG kg	PELLETS kg	kW	WOOD kg	METHANE m³	LPG kg	PELLETS kg	kW
85	5,4	2,1	1,5	-	20,0	2,2	0,8	0,6	-	8,0
95	7,5	2,9	2,1	-	27,0	2,7	1,0	0,7	-	9,1
110	9,1	3,5	2,5	6,9	34,0	3,3	1,3	0,9	2,5	12,3
130	9,1	3,5	2,5	6,9	34,0	4,6	1,8	1,3	3,5	17,1
150	9,1	3,5	2,5	6,9	34,0	5,3	2,1	1,5	4,0	19,6

AMOUNT OF AIR FOR COMBUSTION PER KILOWATT

WOOD = 4 m³

GAS = 2 m³

**Stones**

3.200 kg/m<sup>3</sup>: extremely high performance as far as storing, transferring, and recovering heat

**Fuels**

Wood, gas, pellet, or combination

**Cook plate**

Micro-perforated or smooth, always super warm

**AVPN Certificate**

Both wood or gas-powered

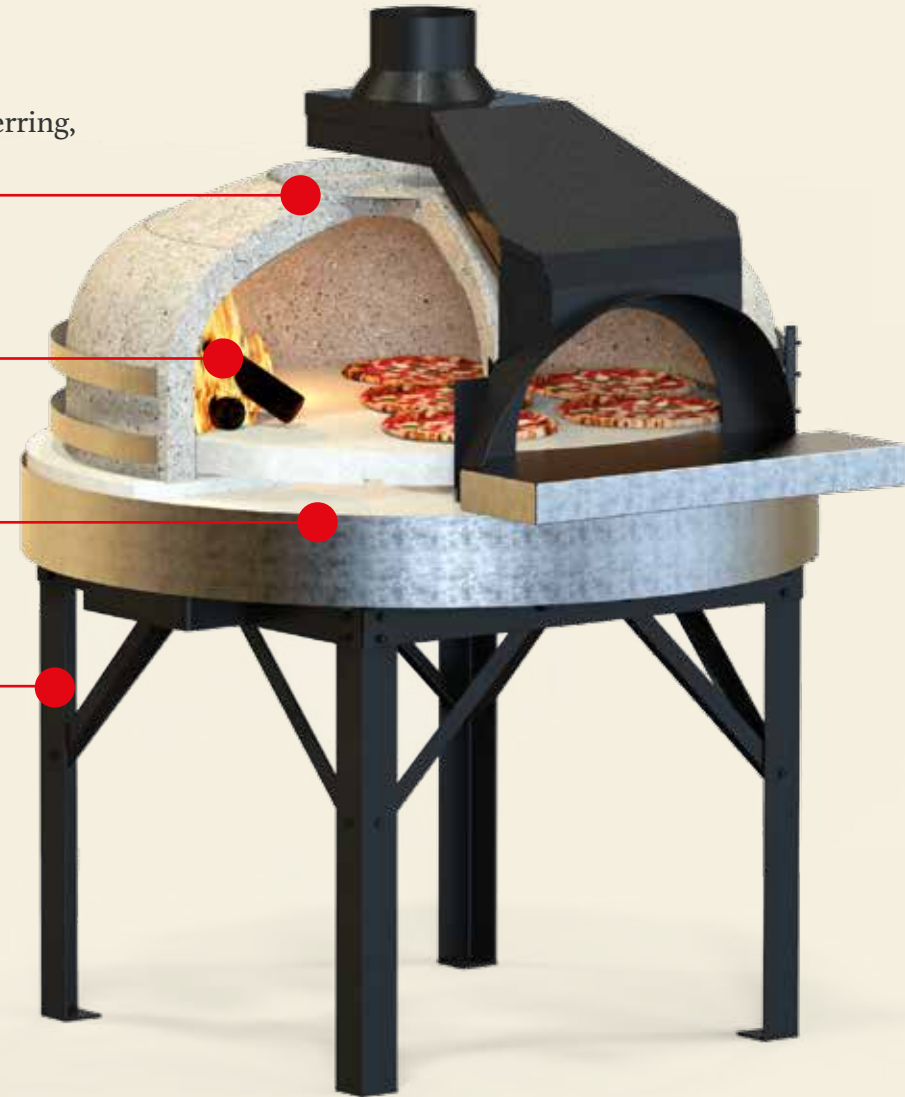



## Fixed ovens

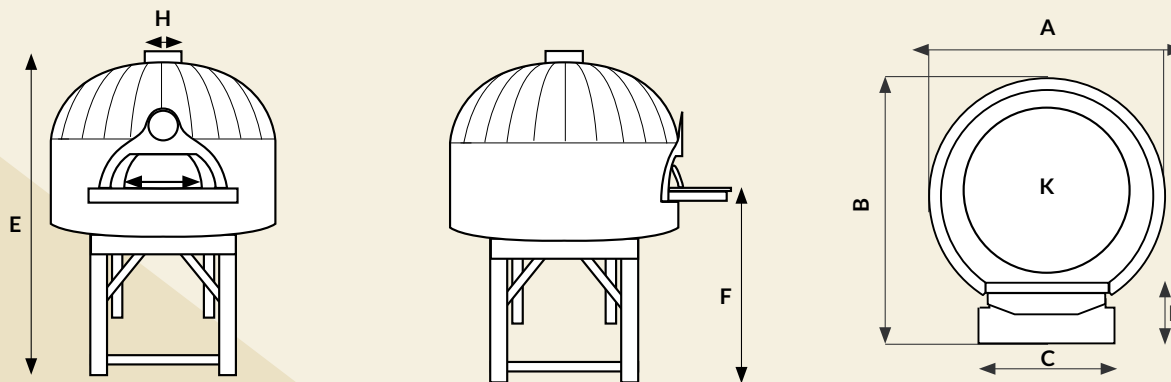

A Oven Width  
E Oven Height

B Oven Depth  
F Counter Height

C Width in front  
G Mouth Width

D Depth of the Front  
H Exhaust Structure Diameter

### Measurements and consumption of the models

MODEL	H	A	B	C	D	E	F	G	K - PIZZA CAPACITY		WEIGHT kg
Napulé	Ø 20	152	176	84	36	194	115	47	WHOOD = Ø 33cm x 5	GAS = Ø 33cm x 7	1105
Fisso 120	Ø 20	152	176	84	36	194	115	47	WHOOD = Ø 33cm x 5	GAS = Ø 33cm x 7	1105

Sizes in centimeters with a +/- 2% variation (\*) Different sizes upon request.

Characteristics of the Gas System	REQUIRED PRESSURE		Ø GAS BURNER CONNECTION
	METHANE - 20 Mbar	LPG or the like - 37 Mbar	¾ INCH MALE COUPLING

MODEL	HOURLY CONSUMPTION OF FUEL - HEATING				HOURLY CONSUMPTION OF FUEL - COOKING			
	WOOD kg	METHANE m³	LPG kg	kW	WOOD kg	METHANE m³	LPG kg	kW
Napulé	7,5	2,9	2,1	27,0	2,7	1,0	0,7	9,1
Fisso 120	7,5	2,9	2,1	27,0	2,7	1,0	0,7	9,1

AMOUNT OF AIR FOR COMBUSTION PER KILOWATT	WOOD = 4 m³	GAS = 2 m³

# Model 85

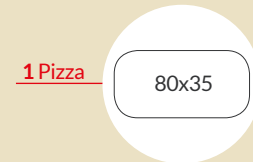
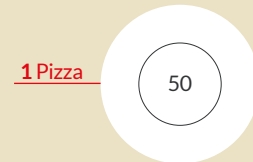
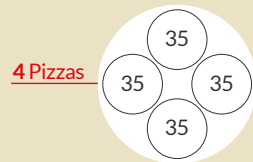
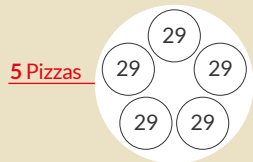
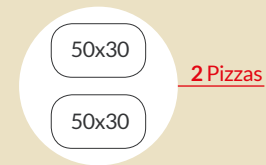
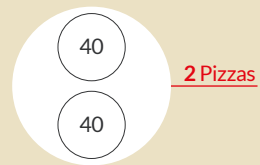
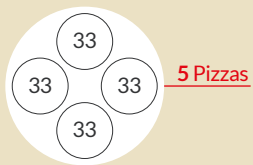
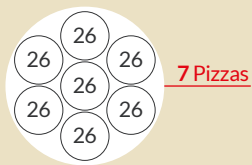

# Model 95

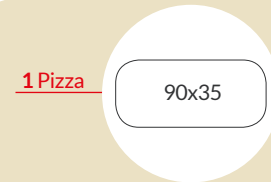
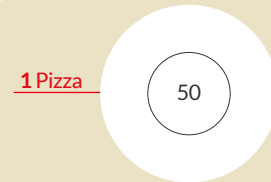
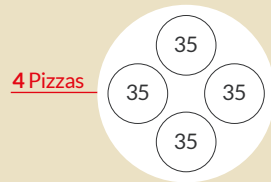
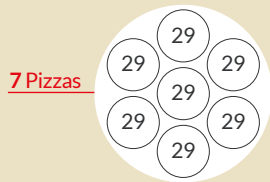
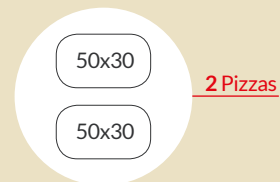
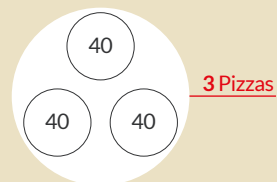
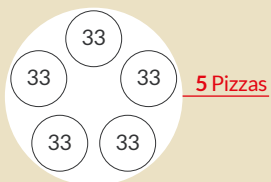
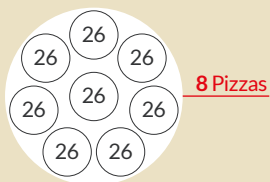

# Model IIO

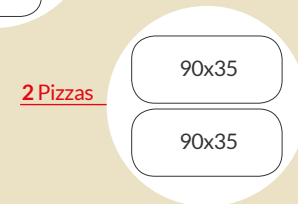
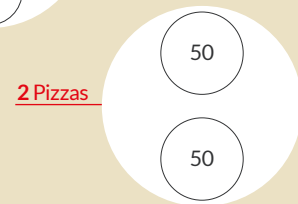
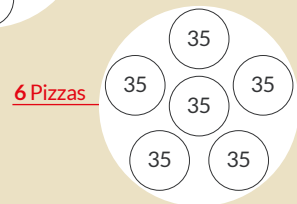
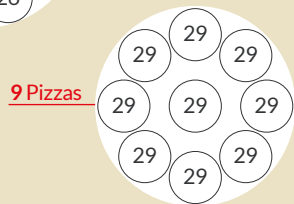
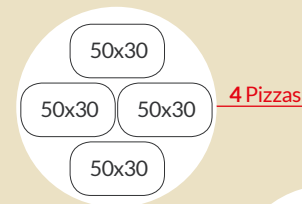
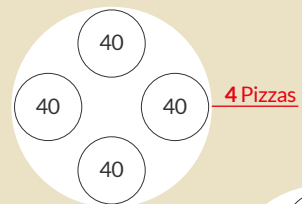
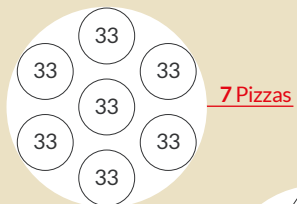
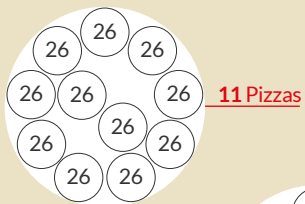

# Model I30

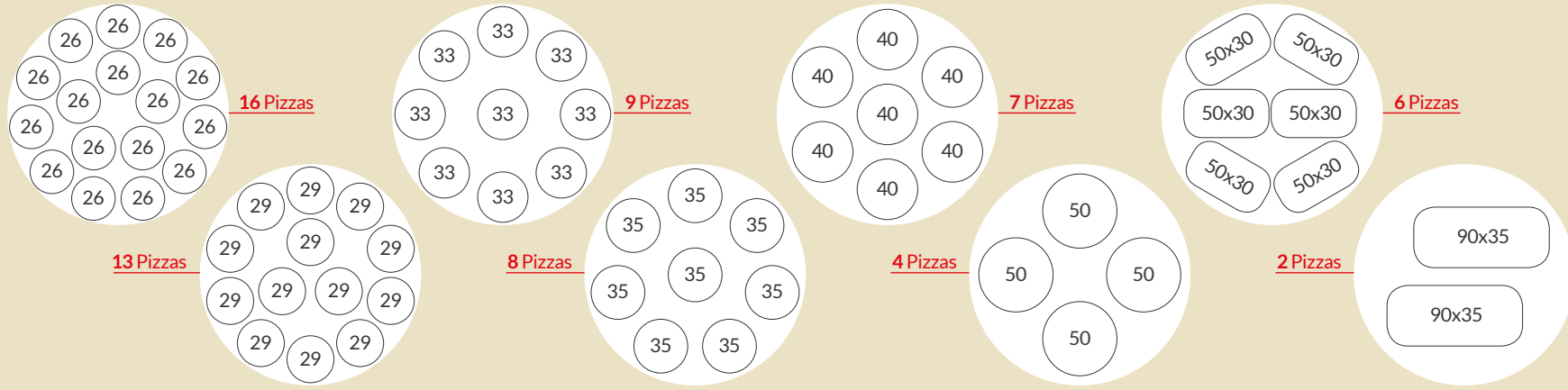

# Model I50

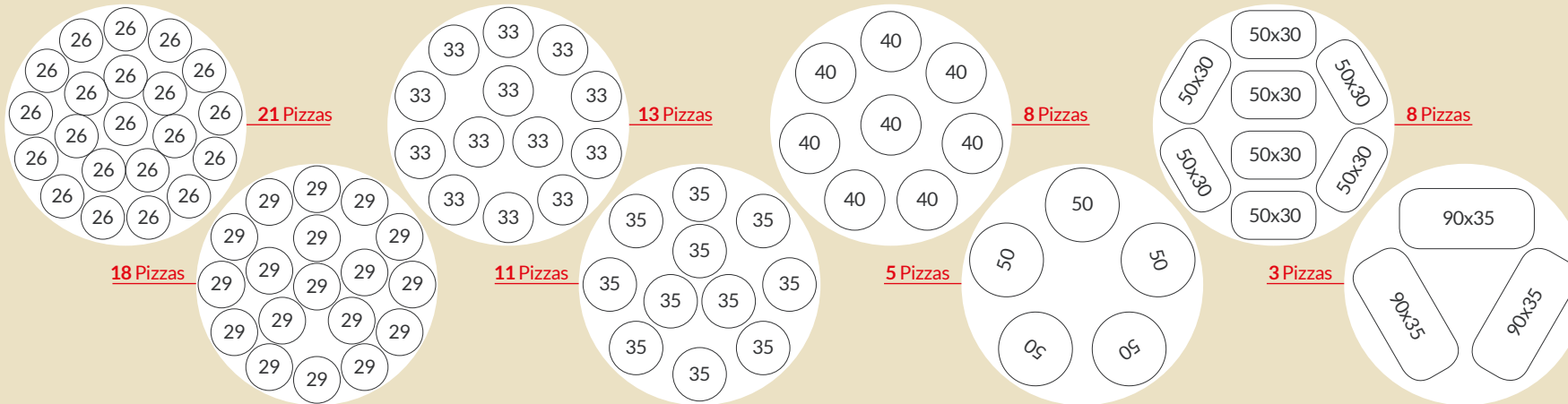

# Model Napulé & Fisso I20

● Gas Burner

◐ Wood fire

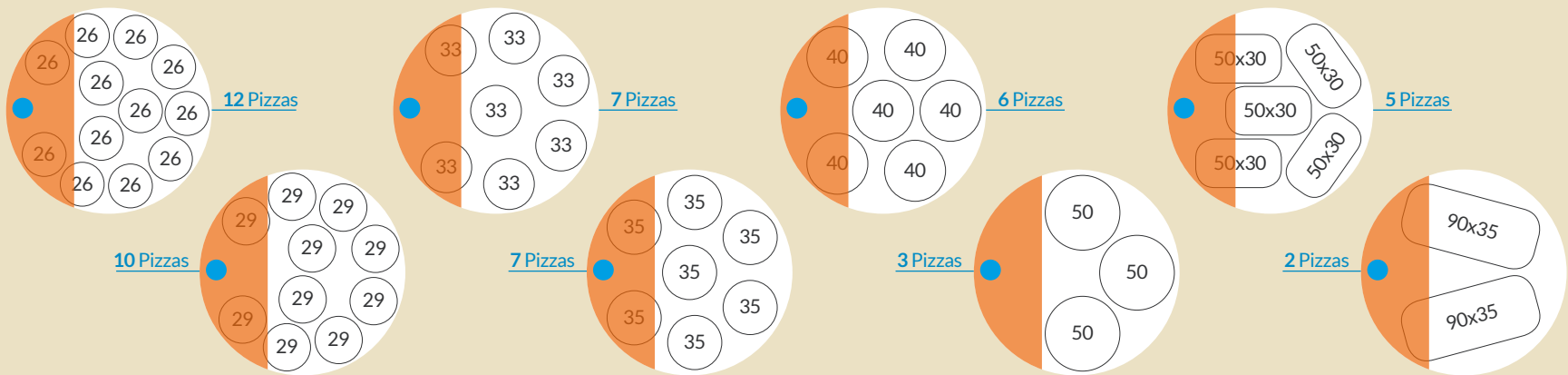

## Technical information, weight, and measurements

	Model	Weight	Outside Dimensions (depth x width) +/- 1% variation	Ø Chimney WOOD (recommended)	Ø Chimney GAS (recommended)
<b>Rotoforno SU&amp;GIU</b>	<b>85</b>	770 kg	136x136	20/25 cm	20 cm
	<b>95</b>	940 kg	152x152	20/25 cm	20 cm
<b>Rotoforno Classico</b>	<b>110</b>	1400 kg	180x180	20/25 cm	20 cm
	<b>130</b>	1710 kg	200x200	20/25 cm	20 cm
<b>Rotoforno Genius</b>	<b>150</b>	2170 kg	220x220	20/25 cm	20 cm

Technical characteristics are subject to changes without notice.

	Model	Weight	Outside Dimensions (depth x width) +/- 1% variation	Ø Chimney WOOD (recommended)	Ø Chimney GAS (recommended)
<b>Trofeo Gea Tanganelli</b>	<b>Trofeo 85</b>	800 kg	140x142	20/25 cm	20 cm
	<b>Gea 150 suspended</b>	2600 kg	220x220	40 cm	40 cm
	<b>Gea 150 freestanding</b>	3200 kg	274x230	40 cm	40 cm
	<b>Tanganelli 110</b>	1730 kg	210x210	20/25 cm	20 cm
	<b>Tanganelli 130</b>	2055 kg	230x230	20/25 cm	20 cm
	<b>Tanganelli 150</b>	2540 kg	250x250	20/25 cm	20 cm

Technical characteristics are subject to changes without notice.

	Model	Weight	Outside Dimensions (depth x width) +/- 1% variation	Ø Chimney WOOD (recommended)	Ø Chimney GAS (recommended)
<b>Fisso 120 Napulé</b>	<b>Fisso 120</b>	1105 kg*	176x152	20 cm	20 cm
	<b>Napulé 120</b>	1105 kg*	176x152	20 cm	20 cm

\*The covering weight is just 60 kg.

## Hourly consumption of fuel

MODEL	HEATING					COOKING				
	WOOD kg	METHANE m <sup>3</sup>	LPG kg	PELLETS kg	kW	WOOD kg	METHANE m <sup>3</sup>	LPG kg	PELLETS kg	kW
<b>85</b>	5,4	2,1	1,5	-	20,0	2,2	0,8	0,6	-	8,0
<b>95 / Fixed</b>	7,5	2,9	2,1	-	27,0	2,7	1,0	0,7	-	9,1
<b>110</b>	9,1	3,5	2,5	6,9	34,0	3,3	1,3	0,9	2,5	12,3
<b>130</b>	9,1	3,5	2,5	6,9	34,0	4,6	1,8	1,3	3,5	17,1
<b>150</b>	9,1	3,5	2,5	6,9	34,0	5,3	2,1	1,5	4,0	19,6

The hourly consumption is calculated as an average statistic with the oven running full force and is subject to different variables, which for example include: fuel yield; percent of moisture in the wood, gas pressure, experience and ability of the person working the oven, draught quality, flame chosen to cook with (Napulé Oven)

## Average fuel yield

<b>WOOD: 1 kg = 3,7 kW</b>	<b>GAS METHANE: 1 m<sup>3</sup> = 9,5 kW</b>	<b>GAS LPG: 1 kg = 13,1 kW</b>	<b>PELLETS: 1 kg = 4,9 kW</b>
----------------------------	--	--------------------------------	-------------------------------

By request of the installers, we can provide the smoke test conducted by IMQ based on the DIN 18891 standard

## Chimneys and draught sheets

MODEL	EXHAUST TEMPERATURE	FLUE DRAUGHT	EXHAUST PIPE EXHAUST COUPLING	EXHAUST EMISSION m <sup>3</sup> PER HOUR
<b>85</b>	Max: 206 °C Average: 152 °C	15 Pa	Ø 200mm	150
<b>95 / Fixed</b>	Max: 206 °C Average: 152 °C	15 Pa	Ø 200mm	150
<b>110</b>	Max: 206 °C Average: 152 °C	15 Pa	Ø 200mm	150
<b>130</b>	Max: 214 °C Average: 157 °C	15 Pa	Ø 200mm	235
<b>150</b>	Max: 205 °C Average: 134 °C	15 Pa	Ø 200mm	263

An airflow of at least 2 m<sup>3</sup> per hour per kilowatt installed has to be guaranteed for the gas, whatever the type.



# These Italian-made ovens are all over Italy and in 85 countries around the world.

Our widespread sales network is available to customers to introduce the Marana ovens  
and how they have revolutionized how we make pizza in terms of cooking quality and fast service.

## Marana Forni around the world



Marana Forni is **official technical sponsor** of the main events centered around the world of pizza and goes to **trade fairs and shows** on the five continents.

Get in touch with our sales office to get up-to-date information on the events where Marana ovens will be, and come and see and try out our ovens in person.

You can bring your dough or your raw ingredients to Marana Forni **showrooms** around the world –whose doors are always open to customers– and use our ovens.

You will be attended to during tests in order to ascertain the perfect cooking and ideal work method, as well as give any suggestions for your place.



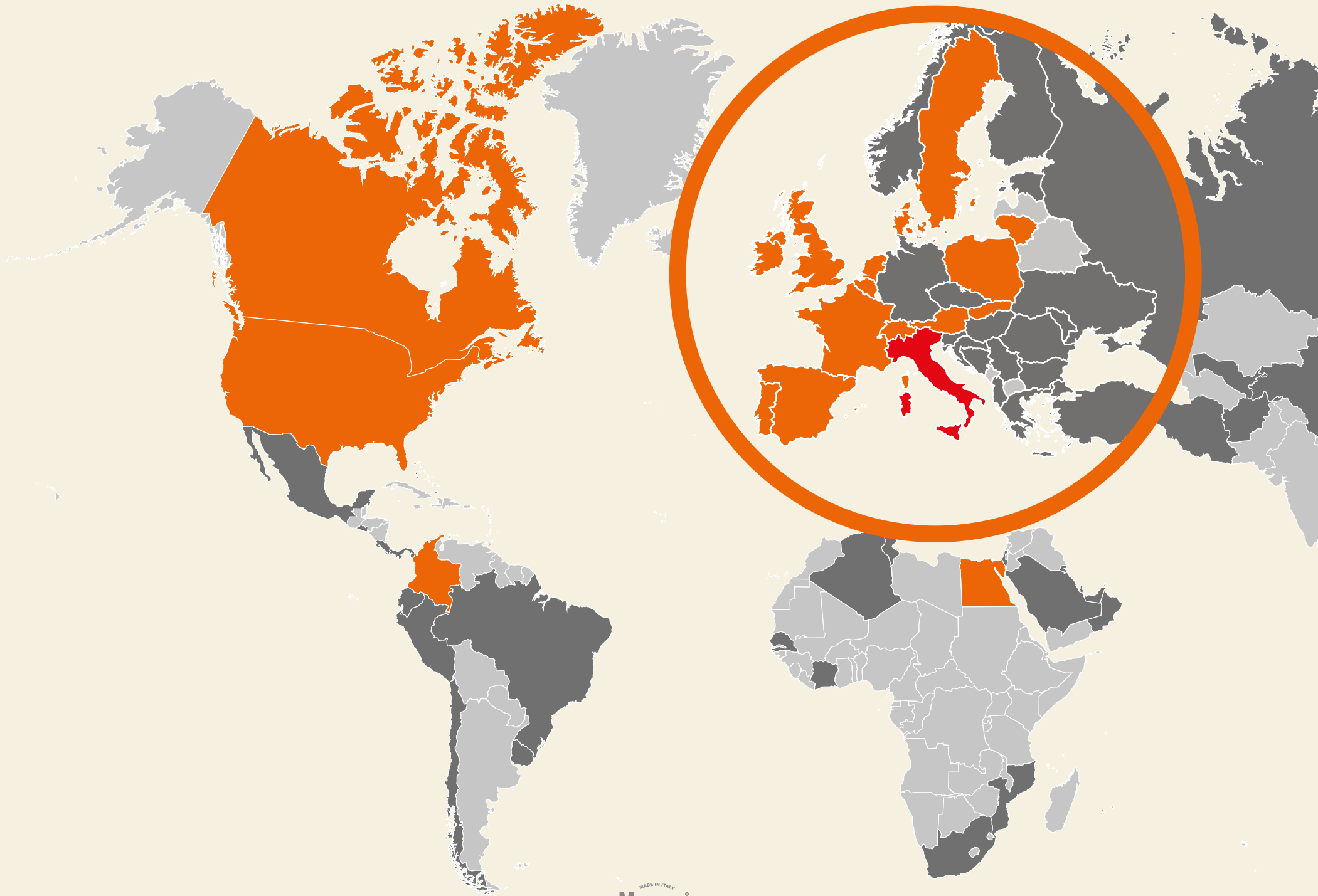



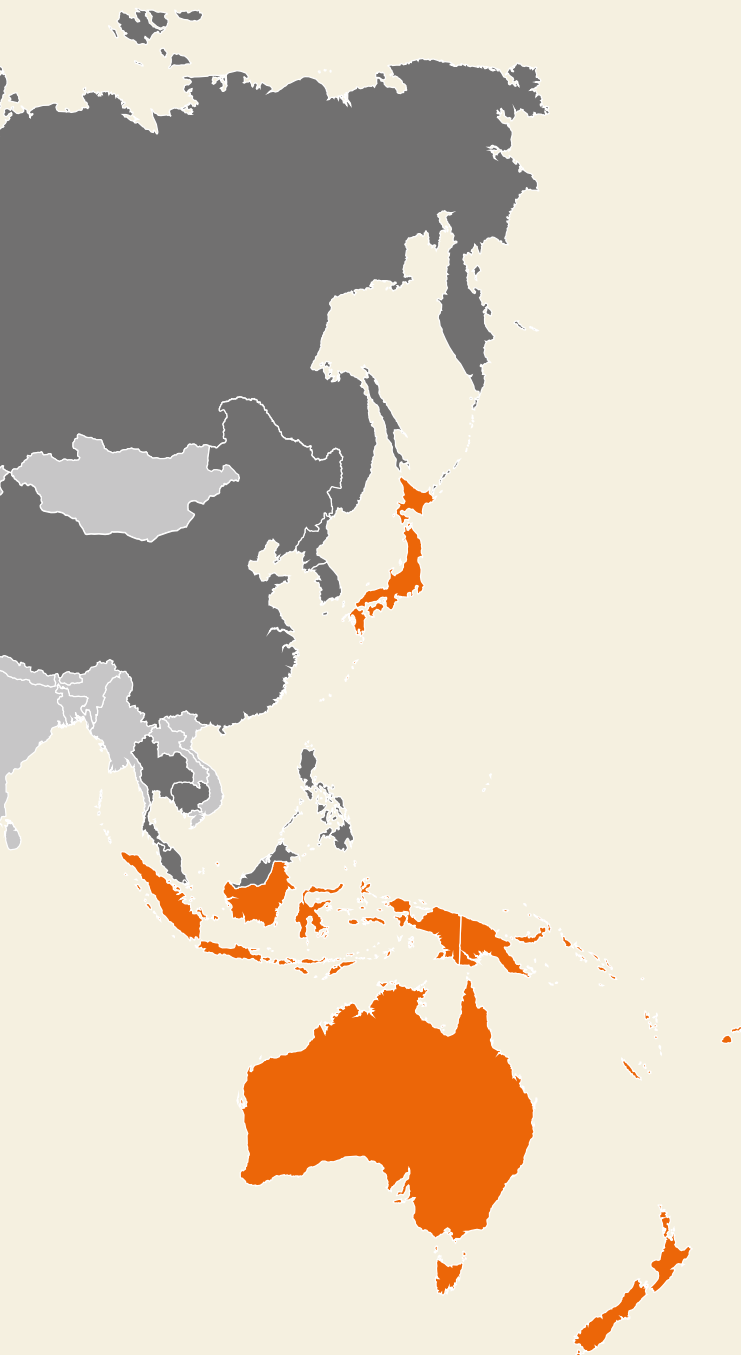



## WE ARE IN 85 COUNTRIES AROUND THE WORLD

- |                    |               |                      |
|--------------------|---------------|----------------------|
| Afghanistan        | Germany       | Poland               |
| Albania            | Greece        | Portugal             |
| Algeria            | Guadalupe     | Qatar                |
| Andorra            | Hungary       | Rep. of San Marino   |
| Antilles           | Indonesia     | Romania              |
| Armenia            | Iran          | Russia               |
| Australia          | Ireland       | Saudi Arabia         |
| Austria            | Israel        | Senegal              |
| Bahamas            | Italy         | Serbia               |
| Belgium            | Ivory Coast   | Seychelles           |
| Bosnia-Herzegovina | Japan         | Singapore            |
| Brazil             | Kosovo        | Slovakia             |
| Bulgaria           | Kuwait        | Slovenia             |
| Cambodia           | Lithuania     | South Africa         |
| Canada             | Luxembourg    | South Korea          |
| Chile              | Malaysia      | Spain                |
| China              | Malta         | Sweden               |
| Colombia           | Mexico        | Switzerland          |
| Costa Rica         | Moldavia      | Thailand             |
| Croatia            | Mozambique    | Tunisia              |
| Czech Republic     | Netherlands   | Turkey               |
| Denmark            | New Caledonia | Ukraine              |
| Ecuador            | New Zealand   | United Arab Emirates |
| Egypt              | Norway        | United Kingdom       |
| El Salvador        | Oman          | Uruguay              |
| Estonia            | Panama        | USA                  |
| Finland            | Peru          | Uzbekistan           |
| France             | Philippines   |                      |

 presence of local distributors

 Marana ovens

Our ovens  
around the world





## Create your next **Marana** oven

	Model	Fuel type	Extra	Coverings	Flame side
<b>Rotoforno SU&amp;GIU®</b>	<input type="checkbox"/> 95	<input type="checkbox"/> Wood	<input type="checkbox"/> Energy sav. Door	<input type="checkbox"/> Napoli Dome	<input type="checkbox"/> Right
	<input type="checkbox"/> 110	<input type="checkbox"/> Gas	<input checked="" type="checkbox"/> Designs	<input type="checkbox"/> Gea	<input type="checkbox"/> Left
	<input type="checkbox"/> 130	<input type="checkbox"/> Pellet	<input type="checkbox"/> Turbo wood or gas	<input type="checkbox"/> Tanganelli	
	<input type="checkbox"/> 150	<input type="checkbox"/> Combination			
<b>Rotoforno Classico</b>	<input type="checkbox"/> 95	<input type="checkbox"/> Legna	<input type="checkbox"/> Energy sav. Door	<input type="checkbox"/> Napoli Dome	<input type="checkbox"/> Right
	<input type="checkbox"/> 95	<input type="checkbox"/> Gas	<input checked="" type="checkbox"/> Designs	<input type="checkbox"/> Gea	<input type="checkbox"/> Left
	<input type="checkbox"/> 110	<input type="checkbox"/> Pellet	<input type="checkbox"/> Turbo wood or gas	<input type="checkbox"/> Tanganelli	
	<input type="checkbox"/> 130	<input type="checkbox"/> Combination		<input type="checkbox"/> Trofeo	
	<input type="checkbox"/> 150				
<b>Rotoforno Genius</b>	<input type="checkbox"/> 110	<input type="checkbox"/> Legna	<input type="checkbox"/> Energy sav. Door	<input type="checkbox"/> Napoli Dome	<input type="checkbox"/> Right
	<input type="checkbox"/> 130	<input type="checkbox"/> Gas	<input checked="" type="checkbox"/> Designs	<input type="checkbox"/> Gea	<input type="checkbox"/> Left
	<input type="checkbox"/> 150	<input type="checkbox"/> Combination	<input checked="" type="checkbox"/> Turbo wood or gas	<input type="checkbox"/> Tanganelli	
<b>Napulé</b>	ONLY	<input type="checkbox"/> Wood <input type="checkbox"/> Gas	<input type="checkbox"/> Energy sav. Door <input type="checkbox"/> Smooth plate <input type="checkbox"/> Micro-perforated plate	<input type="checkbox"/> Napoli Dome	<input type="checkbox"/> Right <input type="checkbox"/> Left
<b>Fisso 120</b>	ONLY	<input type="checkbox"/> Wood <input type="checkbox"/> Gas	<input type="checkbox"/> Energy sav. Door <input type="checkbox"/> Smooth plate <input type="checkbox"/> Micro-perforated plate	<input type="checkbox"/> Napoli Dome	<input type="checkbox"/> Right <input type="checkbox"/> Left

## Reviews

The following comments are taken from and verifiable on our social networks

It's an oven that handles high numbers...**and never lets you down.**

Fabio Mastino

In my business, I've tried the oven for Naples-style pizzas with the new gas burner and I have to say it's excellent. I've also tried the wood-fired oven, and with the same results. **Recommended** by the FUSCO TWINS.

Danilo Fusco

The rotating oven solves problems, big time...**I have had two** for about 7 years and I paid them back in one summer season.

Corrado Caporali

I bought a SU&GIU 130 rotating oven for Neapolitan pizza. **It's a rocket**, I'm absolutely thrilled!

Riccardone pizza

**A very professional company with the highest-quality products**, both in terms of their pizza ovens and from a support point of view. For me –I work in the hospitality industry and pizzerias– they're the number one. In my view, Marana Forni is unique.

Antonio Davalos

**This is one mighty oven** If you come across this oven in a pizzeria it means that whoever is making the pizzas is a proper pizza chef.

Michele Scopelliti

**Excellent, practical and most of all a massive help.** Whoever is critical before trying it is an idiot: try it and then we'll speak. I can assure you because I too was sceptical. I can recommend it from first-hand experience.

Massimo Di Pasquale

Over the past year or so, due to this oven **working to perfection**, I've made almost double the number of pizzas than last year.

Walter Icardi

I've worked for 18 years with the SU&GIU oven – **exceptional, robust and practical.**

Claudio Palumbo

Ever since I tried these ovens, **I can't live without them**

Attilio Albachiara

I bought the oven 11 years ago. one word is enough: **excellent.** many thanks to an excellent company.

Teo Lanzillotti

**Marana ovens: a guarantee.** I've eaten a lot of pizzas in my life and, honestly, in terms of baking only Marana ovens have been up to scratch. Keep it up, fly the Made in Italy flag all over the world.

Raffaella Odituro

Excellent ovens, from the rotary to the Napulé.

Michele Montesarchio



**UK Distributors - Pizza Equipment & Supplies**

Unit 8 | Padgets Lane | Redditch | Worcestershire | B98 0RA

Tel. 01527 905349

[info@pizzequipment.co.uk](mailto:info@pizzequipment.co.uk)

[www.pizzequipment.co.uk](http://www.pizzequipment.co.uk)

